

Automotive Relays

EV-A RELAYS

(DC Contactors)

Product Catalog

**IN Your
Future**

EV-A RELAYS (DC Contactors)

High voltage & High Capacity Relays realized 500 V DC cut off

◀ Protective construction ▶
Capsule contact

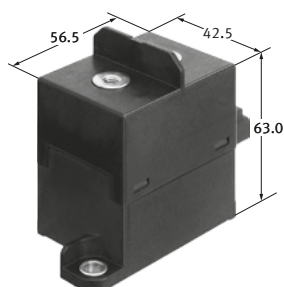

(Unit: mm)

FEATURES

- One of the smallest and lightest weight in 250 A class
- Realized 8,000 A short circuit tolerance
- High cut-off capacity 1,800 A at 500 V DC without contact polarity

APPLICATIONS

- Electric vehicles (PHEV, BEV, FCV etc.)
- Fast charging and Charging station
- DC high voltage circuits for AGV, construction machinery, agricultural machinery, etc.

ORDERING INFORMATION (PART NO.)

AEVA

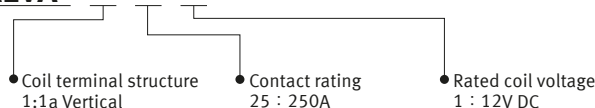

Note) Horizontal type, coil voltage 24 V DC and connector included type are available.
Please contact our sales representative.

TYPES

Contact rating	Contact arrangement	Rated coil voltage	Part No	Packing
				Carton.
250 A	1 Form A	12 V DC	AEVA1251	20 pcs. (packed with 20 pcs./1 tray)

RATING

Coil data

Rated coil voltage	Operate voltage (at 20 °C) (Initial)	Release voltage (at 20 °C) (Initial)	Rated operating current (±10 % , at 20 °C)	Coil resistance (±10 % , at 20 °C)	Rated operating power (at 20 °C)	Usable voltage range*
12 V DC	Max. 9.0 V DC	Min. 0.5 V DC	0.5 A	24 Ω	6.0 W	10 V DC to 16 V DC

* Max. continuous applied voltage to the coil is the maximum value in the allowable voltage range.

Automotive Relays EV-A RELAYS (DC Contactors)

Specifications

Item	Specifications	
Contact data	Contact arrangement	1 Form A
	Contact material	Copper alloy
	Rated switching capacity (resistive)	250 A 500 V DC (Carry, 50mm ² wire)
	Max. carrying current	250 A continuous (50 mm ² wire)
	Min. switching load (resistive) *1	1 A 12 V DC (at 20 °C)
	Contact voltage drop (initial)	Max. 0.125 V (250 A carry current)
	Short circuit capacity	8,000 A (at Max. 5 ms), No smoke and no ignition
Insulation resistance (initial)	Min. 100 MΩ (at 1,000 V DC, Measurement portion is the same as the case of dielectric strength.)	
Dielectric strength (initial)	Between open contacts	2,500 Vrms for 1 min (Detection current: 10 mA)
	Between contact and coil	2,500 Vrms for 1 min (Detection current: 10 mA)
Time characteristics (initial)	Operate time	Max. 50 ms (at rated coil voltage at 20 °C, without bounce)
	Release time	Max. 30 ms (at rated coil voltage at 20 °C, with no coil protective elements)
Shock resistance	Functional	For ON : Min. 588 m/s ² (half-sine shock pulse: 11 ms, detection time: 10 μs) For OFF: Min. 147 m/s ² (half-sine shock pulse: 11 ms detection time: 10 μs)
	Destructive	Min. 588 m/s ² (Half-sine shock pulse: 11 ms)
Vibration resistance	Functional	10 to 200 Hz, 44.1 m/s ² (detection time: 10 μs)
	Destructive	10 to 200 Hz, 44.1 m/s ² (Time of vibration for each direction; X, Y, Z direction: 4 hours)
Expected life	Mechanical life	Min. 2×10 ⁵
	Switch off life *2 *3	1,800 A 500 V DC, Min. 1 operation (No polarity)
	Inrush resistance current (capacitor)	140 A 20 V DC, Min. 70,000 operations
Conditions	Conditions for usage, transport and storage*4	Ambient temperature: -40 to +85 °C Humidity : 5 to 85 % R.H. (Avoid icing or condensation)
	Unit Weight	Approx. 400 g

*1: This value can change due to the switching frequency, environmental conditions, and desired reliability level, therefore it is recommended to check this with the actual load.

*2: Coil applied voltage is 12 V DC and a varistor is connected in parallel. If a protective element is connected, please refer to " Other cautions for use " 3.

*3: at L/R ≤ 1 ms

*4: The upper operation ambient temperature limit is the maximum temperature that can satisfy the coil temperature rise value. For details, please refer to the " Automotive Relay Users Guide " .

REFERENCE DATA

1. Ambient temperature characteristics

Sample : AEVA1251, 6 pcs.

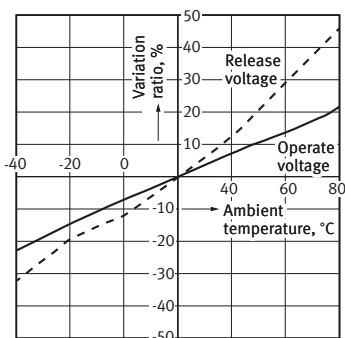

2. Max. switching capacity

Sample : AEVA1251

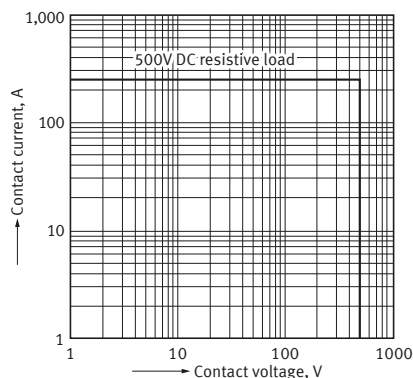

3. Switching life curve (Forward direction)

Sample : AEVA1251

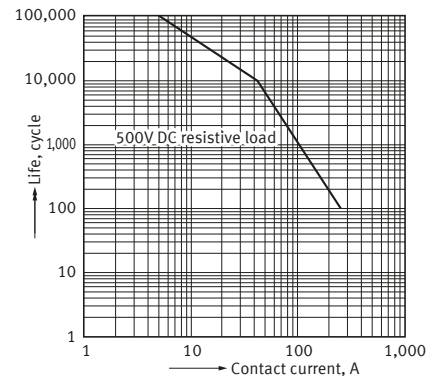

Automotive Relays EV-A RELAYS (DC Contactors)

4. Switch-off life curve

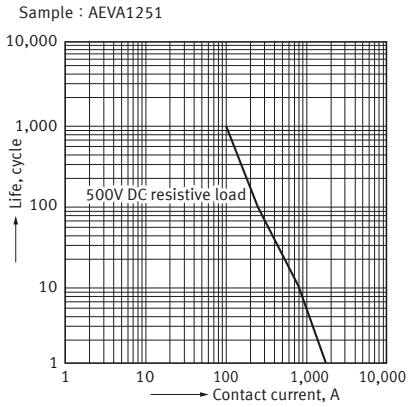

5. Carrying performance life curve (85 °C)

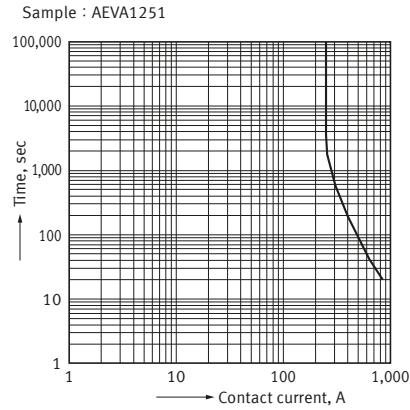

DIMENSIONS (Unit: mm)

CAD The CAD data of the products with a " CAD " mark can be downloaded from our Website.

CAD



External dimensions

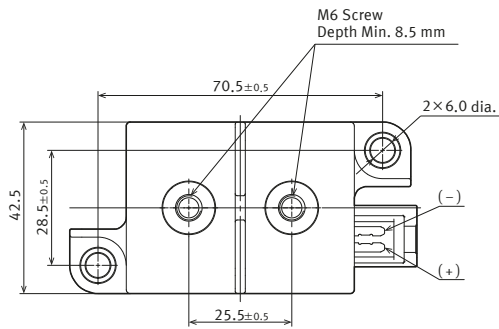

Schematic (TOP VIEW)

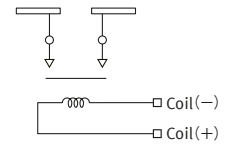

No polarity on the load side.
Coil side has polarities (+) and (-).

Mounting dimensions

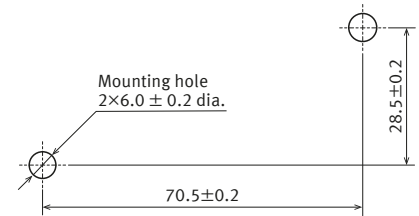
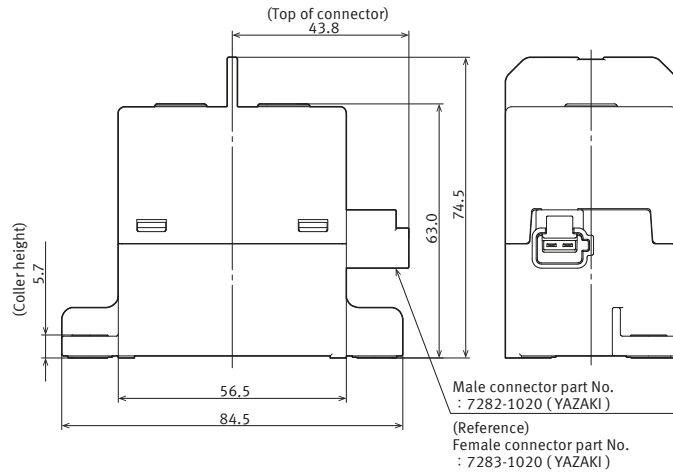

Tolerance;
Less than 10 mm ± 0.3
10 to 50 mm ± 0.6
More than 50 mm ± 1.0

Automotive Relays EV-A RELAYS (DC Contactors)

NOTES

■ Safety precautions

We are doing our best to constantly improve the quality and reliability of our products. However, some electric items/ components do in fact fail despite our efforts. The durability of products also varies depending on service environments and conditions. Please check your product under actual service conditions before use.

If you continue to use a product in a poor condition, items with deteriorated insulation performance may generate abnormal heat or smoke or even ignite. The product's failure or end of service life may cause accidents involving risks to human health, fire, or danger to the public at large. We advise you to apply safety measures and regular maintenance work, such as the use of redundant design, fireproofing, and malfunction-preventing design, to rule out such accidents.

■ For general cautions for use, please refer to the " Automotive Relay Users Guide " .

■ Precautions when using EV-A relays

● Usage, transport and storage conditions

1) Ambient temperature, humidity and air pressure during usage, transport and storage of the relay.

(1) Temperature: -40 to $+85$ °C

(2) Humidity: 5 to 85 %RH

(Avoid icing and condensation.)

Notes) The humidity range varies with the temperature.
Use within the range indicated in the graph below.

(3) Air pressure: 86 to 106 kPa

[Temperature and humidity range for usage, transport, and storage]

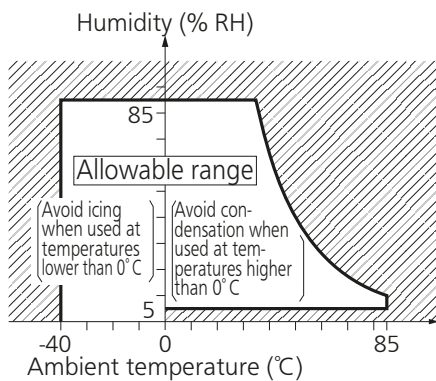

2) Water condensation

Water condensation occurs when the ambient temperature drops suddenly from a high temperature and humidity, or the relay is suddenly transferred from a low ambient temperature to a high temperature and humidity. Condensation causes the failures like insulation deterioration, wire disconnection and rust etc. Panasonic Industry Co., Ltd. does not guarantee the failures caused by condensation.

The heat conduction by the equipment may accelerate the cooling of relay itself, and the condensation may occur. Please confirm no condensation in the worst condition of the actual usage.

(Special attention should be paid when high temperature heating parts are close to the relay. Also, please consider the condensation may occur inside of the relay.)

3) Icing

Please check the icing when an ambient temperature is lower than 0 °C. Icing means, the moisture contained in the surrounding environment and inside the relay freezes when the ambient temperature falls below the freezing point. The icing causes the sticking of movable portion, the operation delay and the contact conduction failure etc.

Panasonic Industry Co., Ltd. does not guarantee the failures caused by the icing.

The heat conduction by the equipment may accelerate the cooling of relay itself and the icing may occur. Icing condition is changed by ambient environment, please make sure to confirm no icing in the worst condition of the actual usage.

4) Low-temperature, low-humidity atmosphere

If the relay is exposed to a low-temperature, low-humidity atmosphere for a long time, its plastic parts may become brittle and fragile.

5) Storage

Do not keep under high-temperature and high-humidity.

Automotive Relays EV-A RELAYS (DC Contactors)

- When installing the relay, always use washers to prevent the screws from loosening.
- Condition of tightening screw
Tightening torque for fixing relay body (M5 screw): 3.0 Nm to 4.0 Nm
Tightening torque for fixing contact terminals (M6 screw): 6.0 Nm to 8.0 Nm
- Electrical life
This relay is a high-voltage direct-current switch. In its final breakdown mode, it may lose the ability to provide the proper switch-off. Therefore, do not exceed the indicated switching capacity and life.
(Please treat the relay as a product with limited life and replace it when necessary.)
In the event that the relay loses switch-off ability, there is a possibility that burning may spread to surrounding parts, so configure the layout so that the power is turned off within one second.

- Permeation life of internal gas
This relay uses a hermetically encased contact (capsule contact) with gas inside. The gas has a permeation life that is affected by the temperature inside the capsule contact (Ambient temperature and temperature rise due to flow of electrical current). For this reason, make sure the ambient operating temperature is between -40 and $+85$ °C, and the ambient storage temperature is between -40 and $+85$ °C.
- The coil of the relay is polarized, so follow the connection schematic when connecting the coil.
- Be careful that foreign matter and oils and fats kind don't stick to the main terminal portion because it is likely to cause terminal portion to give off unusual heat.
- Avoid excessive load applied to the terminal in case of installing such as a bus bar etc., Because it might adversely affect the switching performance.
- Use the specified connector for the connector terminal connection.

Yazaki Corporation: 7283-1020 or equivalent

Other cautions for use

- 1) Please make sure to contact our sales representative when the product is used not in accordance with its specifications. Your nearest sales office will review the required specification from your company and perform confirmation tests in actual condition as needed.
- 2) When the voltage is applied to the relay coil beyond the max. allowable voltage range, the relay operation cannot be assured. Additionally the ambient temperature and condition of your application should be considered under the worst condition of the actual usage because they may change the relay operate and release voltage.

* It is not allowed to apply the continuous maximum voltage to the coil. In order to obtain the specified performance, please apply the rated voltage.

- 3) If it includes ripple, the ripple factor should be max. 5 %. In addition, do not have a parallel connection with diode for the purpose of coil surge absorber. If only diode is connected in parallel to the relay coil, break performance of relay cannot be assured because contact release speed becomes slower. So do not use such a circuit. Instead of diode, a Varistor or Zener diode (ZD) when clamp voltage is 1.5 times larger than the rated voltage (Min. 18 V for the rated 12 V-relay), shall be used for the absorber.

Ex. 1 When Varistor is used

Recommended Varistor	Energy capability: Min 1 J (However, please set up the value with consideration of the worst value in use condition.)
Varistor Voltage	Min. 18 V at 12 V DC

Ex. 2 When Zener diode (circuit) is used

[1]

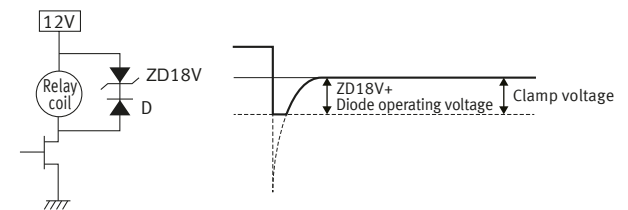

[2]

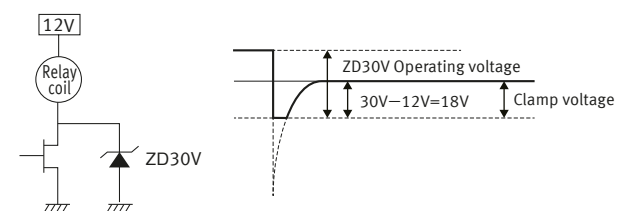

- 4) Lifetime is specified under the standard test conditions in JIS C 5442. (temperature 15 °C to 35 °C humidity 25 %RH to 75 %RH) Lifetime is dependent on the coil driving circuit, load type, operation frequency and ambient conditions. Check lifetime under the actual condition.

We can not guarantee the relay's quality in case the relay is operated without load current. (Dry switching)

- 5) If the relay is dropped, it should not be used again.
- 6) This relay cannot be used for switching with AC load.
- 7) Please check the internal connection diagram in the catalog or specification, and connect the terminals correctly. If any wrong connection is made, it may cause circuit damage by unexpected malfunction, abnormal heat, fire, and so on.

Automotive Relays EV-A RELAYS (DC Contactors)

- 8) Please check the insulation distance between each terminal and ground.
- 9) Please perform evaluation under the worst case condition in actual use when new component is adopted and when there is a change of actual use condition in order to enhance the reliability in actual use.
- 10) Please absolutely avoid the ultrasonic and high frequency vibration to the relay that adversely affects its performance.
- 11) Minimum switching load is the lower limit switching current under the micro-load. When the relay is used below minimum switching load, reliability becomes lower. Please use the relay beyond minimum switching load. Additionally, minimum switching load is changed by coil drive circuit, type of load, switching frequency and environment condition. So please confirm the reliability with actual load under the assumed actual environment.
- 12) As for the screws of fixing relay-body and screws of fixing contact terminal, the tightening torque must be within the specified range.
 - The purpose of the tightening torque for the contact terminal is to secure adhesion force (axial force) at the fixing part and provide stable electrical connection. Therefore, do not use the screws (bolts and nuts) which require rotation torque of locking type (prevailing torque type) because sufficient adhesion force (axial force) may not be secured. In addition, if the locking type nut is used, an excessive torque may be applied to the case before generating of axial force and may cause breakage of the case.
 - Regarding the screw for fixing relay body, please use suitable screws after adequate verification at user's side.
- 13) The relay should not be installed near strong magnetic fields (transformers, magnets, etc.) and should not be installed near heat source.
- 14) If the several relays are mounted closely or a heat generation object is close to the relay, it may cause troubles the abnormal temperature-rise and the short insulation distance terminals outside of the relay so please assure the evaluation of the relay under the actual worst condition.
- 15) The relay contacts are encapsulated in an inert gas atmosphere. So, please avoid using or storing beyond the allowable ambient temperature range.
- 16) After that the relay has been applied with the rated voltage and current to the coil continuously and then the relay is once switched off and switched on immediately, the relay coil resistance may be increased due to the coil temperature increase. This will result in higher operate voltage and the value will surpass the rated operate voltage value. In order to avoid this failure, the following countermeasures are recommended.
 - decrease of the load current
 - restriction of time to apply voltage
 - restriction of operating ambient temperature, etc.
- 17) If an inductive load ($L/R > 1 \text{ ms}$) is applied, add surge protection in parallel with the inductive load. If this is not done, the electrical life will be shortened and cut-off failure may occur.
- 18) In case using a capacitive load (C-load), please take a countermeasure as pre-charging to the capacitive load so that the inrush current will not surpass 140 A. The relay may have a contact welding without such countermeasure.
- 19) Use the suitable wire or bus bar according to the current. If the wire diameter is thin, maximum allowable contact current cannot be assured.
- 20) Take care to disconnect from the power supply when wiring.
- 21) The relay satisfies water resistance level of JIS D 0203 R2. Please take any countermeasures additionally if it is installed in the place where higher water resistance level is required.
- 22) Do not use this product in such atmosphere where any kind of organic solvent (as benzene, thinner and alcohol) and the strong alkali (as ammonia and caustic soda) may be adhered to this product.
- 23) Be careful that oils and foreign matter do not stick to the main terminal part because it is likely to cause a terminal part to give off unusual heat.
- 24) Do not make additional manufacturing upon the relay housing.
- 25) Maximum overcurrent value in this specification is limited as single operation only. In the case of multiple operation, this relay may cause malfunction by heating. So, please confirm the temperature/operation using your application. In the case of multiple operation, please stop applying the over current to secure the relay's temperature under the maximum ambient temperature.
- 26) When applying current which includes precipitous changes or ripple, the relay may generate buzzing sound. Therefore, please confirm with the actual load.

Please refer to " **the latest product specifications** " when designing your product.
• Requests to customers:
<https://industry.panasonic.com/global/en/salespolicies>

■ Global Sales Network Information: industry.panasonic.com/global/en/salesnetwork/globalnetwork

Panasonic
INDUSTRY

Panasonic Industry Co., Ltd.

Electromechanical Control Business Division

■ 1006, Oaza Kadoma, Kadoma-shi, Osaka 571-8506, Japan
industry.panasonic.com