

Automotive Relays
CV-N RELAYS

Product Catalog

**IN Your
Future**

CV-N RELAYS

Low profile Micro-ISO Automotive Relay

[Protective construction] Sealed

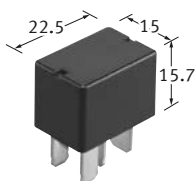

(Unit: mm)

FEATURES

- Low profile automotive relays for Micro-ISO terminal
- Compact and high-capacity load switching

TYPICAL APPLICATIONS

- Headlights, Magnetic clutches, Radiator fans, Blowers, Fog lamps, Tail lights, Heaters, Defoggers and Condenser fans, etc.

ORDERING INFORMATION (PART NO.)

ACVN

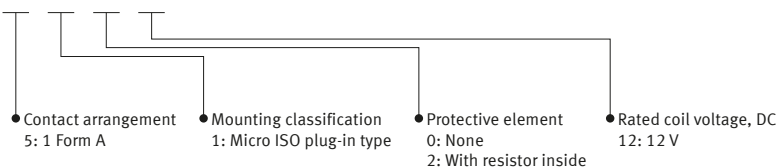

TYPES

Contact arrangement	Rated coil voltage	Part No.	Packing	
			Carton	Case
1 Form A	12 V DC	ACVN51012	50 pcs.	200 pcs.

Note) Please use ACVN**2** to order with resistor inside type. (Asterisks " * " should be filled in from ORDERING INFORMATION.)

RATING

Coil data

Rated coil voltage	Operate voltage (at 20 °C) (initial)	Release voltage (at 20 °C) (initial)	Rated operating current [±10 %] (at 20 °C)	Coil resistance [±10 %] (at 20 °C)	Rated operating power (at 20 °C)	Usable voltage range
12 V DC	Max. 7.0 V DC	Min. 0.5 V DC	66.7 mA 74.7 mA (with resistor inside)	180 Ω 160.7 Ω (with resistor inside)	800 mW 900 mW (with resistor inside)	10 to 16 V DC

Automotive Relays CV-N RELAYS

Specifications

Item		Specifications
Contact data	Contact arrangement	1 Form A
	Contact resistance (initial)	Max. 15 mΩ (typ. 3 mΩ) (By voltage drop 1 A 6 V DC)
	Contact material	Ag alloy
	Rated switching capacity (resistive)	35 A 14 V DC
	Max. carrying current*1	20 A 14 V DC (at 85 °C, continuous)
	Min. switching load (resistive) *2	1 A 14 V DC (at 20 °C)
	Contact voltage drop (initial)	Max. 0.5 V (by voltage drop 14 V DC 35 A)
Insulated resistance (initial)		Min. 20 MΩ (at 500 V DC, Measurement at same location as " Dielectric strength " section.)
Dielectric strength (initial)	Between open contacts	500 Vrms for 1 min (Detection current: 10 mA)
	Between contacts and coil	500 Vrms for 1 min (Detection current: 10 mA)
Time characteristics (initial)	Operate time (at rated voltage)	Max. 10 ms (at 20 °C, without contact bounce time)
	Release time (at rated voltage)	Max. 10 ms (at 20 °C) (without diode)
Shock resistance	Functional	Min. 100 m/s ² (Half-wave pulse of sine wave: 11 ms, detection time: 10 μs)
	Destructive	Min. 1,000 m/s ² (Half-wave pulse of sine wave: 6 ms)
Vibration resistance	Functional	10 to 100 Hz, Min. 44.1 m/s ² (Detection time: 10 μs)
	Destructive	10 to 500 Hz, Min. 44.1 m/s ² Time of vibration for each direction; X, Y, Z direction: 4 hours
Expected life	Mechanical	Min. 10 ⁶ (at 120 times/min)
	Electrical	<Resistive load> Min. 10 ⁵ at rated switching capacity operating frequency: 2 s ON, 2 s OFF <Motor load> Min. 3 × 10 ⁵ at inrush 84 A, steady 18 A 14 V DC operating frequency: 2 s ON, 5 s OFF <Lamp load> Min. 2 × 10 ⁵ at inrush 84 A, steady 12 A 14 V DC operating frequency: 1 s ON, 14 s OFF
Conditions	Conditions for usage, transport and storage*3	Ambient temperature: -40 to +85 °C *4, Humidity: 5 to 85 % RH (Avoid icing and condensation)
Weight		Approx. 12 g

*1: Depends on connection conditions. Also, this does not guarantee repeated switching. We recommend that you confirm operation under actual conditions.

*2: This value can change due to the switching frequency, environmental conditions, and desired reliability level, therefore it is recommended to check this with the actual load.

*3: The upper operation ambient temperature limit is the maximum temperature that can satisfy the coil temperature rise value. For details, please refer to the " Automotive Relay Users Guide " .

*4: Please inquire our sales representative if you will be using the relay in a high temperature atmosphere.

REFERENCE DATA

1. Coil temperature rise

Point measured: Inside the coil
 Carrying current: 20 A
 Coil applied voltage: 12 V, 14 V, 16 V
 Ambient temperature: 85 °C

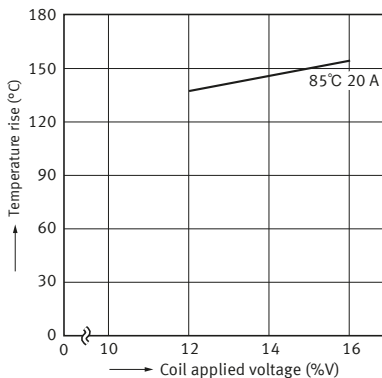

2. Distribution of operate and release voltage

Sample: ACVN51012, 20 pcs

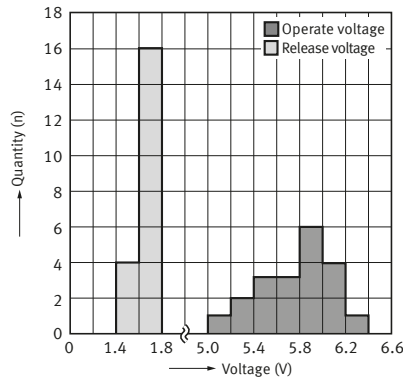

3. Distribution of operate and release time

Sample: ACVN51012, 20 pcs.

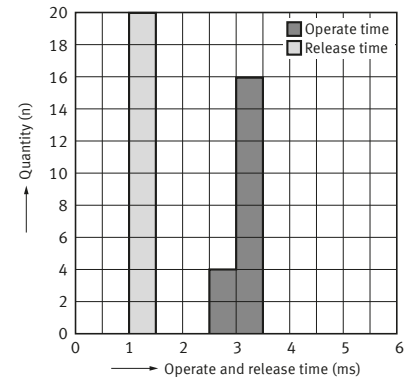

Automotive Relays CV-N RELAYS

4. Ambient temperature and usable voltage range

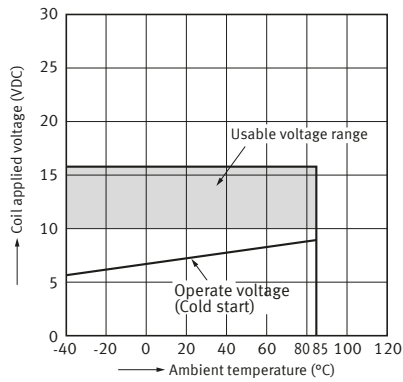

5-1. Electrical life test (Lamp load)

Sample: ACVN51012, 3 pcs.
 Load: Inrush: 84 A, Steady: 12 A,
 halogen lamp load (60W×2)
 Operating frequency: ON 1 s, OFF 14 s
 Ambient temperature: 85°C
 Circuit:

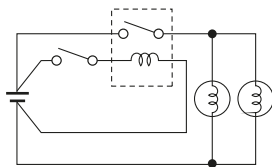

Change of operate and release voltage

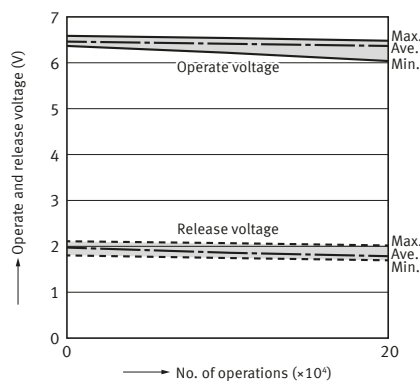

Change of contact resistance

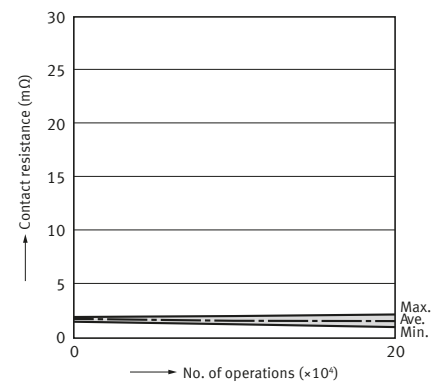

Load current waveform

Load: Inrush current: 84 A, steady current: 12 A

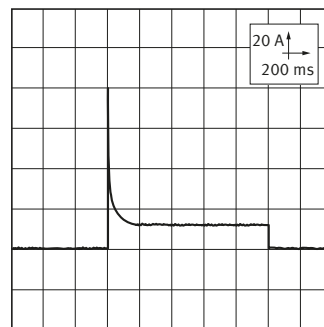

Automotive Relays CV-N RELAYS

5-2. Electrical life test (Motor load)

Sample: ACVN51012, 3 pcs.
 Load: Inrush: 80 A, Steady: 18 A,
 Radiator fan motor (motor free)
 Operating frequency: ON 1 s, OFF 4 s
 Ambient temperature: 85°C
 Circuit:

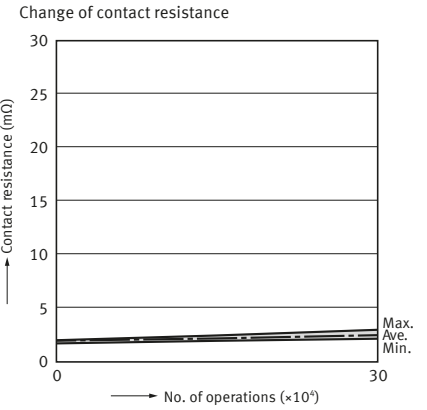
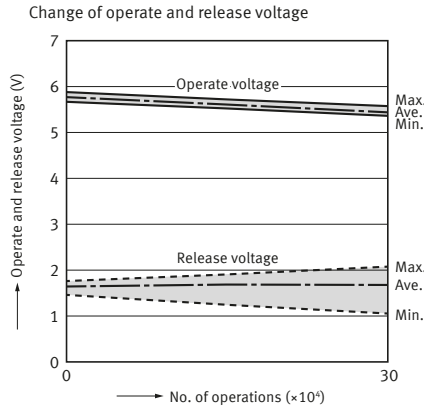
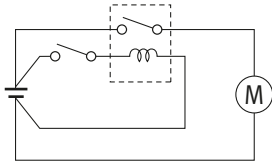

Load current waveform
 Load: Inrush current: 80 A, Steady current: 18 A

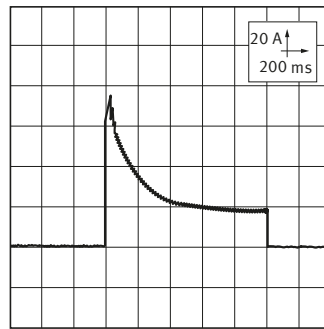

DIMENSIONS (Unit: mm)

CAD The CAD data of the products with a " CAD " mark can be downloaded from our Website.

Micro-ISO plug-in type

CAD



External dimensions

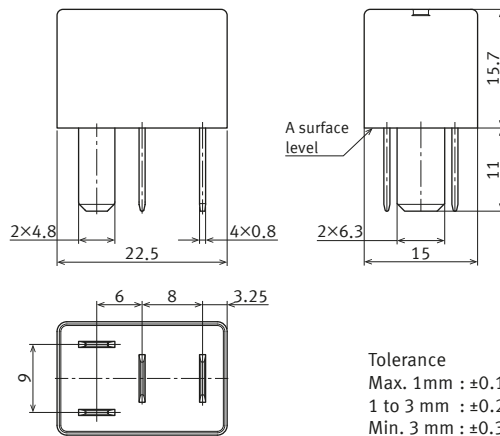

Note: Intervals between terminals is measured at A surface level.

Schematic (BOTTOM VIEW)

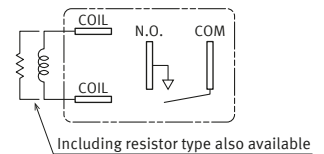

Tolerance
 Max. 1mm : ±0.1
 1 to 3 mm : ±0.2
 Min. 3 mm : ±0.3

GUIDELINES FOR USAGE

For general cautions for use, please refer to the " Automotive Relay Users Guide " .

Please refer to " the latest product specifications " when designing your product.
 • Requests to customers:
<https://industry.panasonic.com/global/en/salespolicies>

■ Global Sales Network Information: industry.panasonic.com/global/en/salesnetwork/globalnetwork

Panasonic
INDUSTRY

Panasonic Industry Co., Ltd.

Electromechanical Control Business Division

■ 1006, Oaza Kadoma, Kadoma-shi, Osaka 571-8506, Japan
industry.panasonic.com